

UNCLASSIFIED//~~FOR OFFICIAL USE ONLY~~



Defense Intelligence Reference Document

Acquisition Threat Support

2 April 2010

ICOD: 1 December 2009

DIA-08-1004-001

Warp Drive, Dark Energy, and the Manipulation of Extra Dimensions

UNCLASSIFIED//~~FOR OFFICIAL USE ONLY~~

Warp Drive, Dark Energy, and the Manipulation of Extra Dimensions

Prepared by:

(b)(3):10 USC 424

Defense Intelligence Agency

Authors:

(b)(6)

Administrative Note

COPYRIGHT WARNING: Further dissemination of the photographs in this publication is not authorized.

This product is one in a series of advanced technology reports produced in FY 2009 under the Defense Intelligence Agency, (b)(3):10 USC 424 Advanced Aerospace Weapon System Applications (AAWSA) Program. Comments or questions pertaining to this document should be addressed to (b)(3):10 USC 424;(b)(6), AAWSA Program Manager, Defense Intelligence Agency, ATTN: (b)(3):10 USC 424 Bldg 6000, Washington, DC 20340-5100.

Contents

| | |
|---|----|
| Introduction..... | v |
| 2. General Relativistic Warp Drives | 1 |
| 2.1 Warp Drive Requirements | 2 |
| 3. The Cosmological Constant | 4 |
| 3.1 Einstein’s Equation and the Introduction of Λ | 4 |
| 4. Casimir Energy and the Quantum Vacuum..... | 5 |
| 4.1 The Casimir Effect | 6 |
| 5. Extra Space Dimensions | 8 |
| 5.1 Kaluza-Klein Theory | 8 |
| 5.2 Large Extra Dimensions..... | 10 |
| 5.3 Randall Sundrum Brane Models..... | 11 |
| 5.4 Extra Dimension Summary | 12 |
| 6. Dark Energy as a Higher Dimensional Artifact..... | 12 |
| 7. Warp Drive and Higher Dimensional Manipulation | 15 |
| 7.1 Adjusting Higher Dimensions for Propulsions | 16 |
| 7.2 The Geometry of Extra Dimensions | 17 |
| 7.3 Higher Dimensions and Stabilization | 17 |
| 7.4 Elementary Warp Drive Calculations | 20 |
| 7.5 Future Experiments..... | 22 |
| 7.6 The Development of the Technology | 23 |
| 8. Summary..... | 24 |

Figures

| | |
|--|----|
| Figure 1. York Extrinsic Time (ϑ) Plot..... | 1 |
| Figure 2. The Interior Region of Parallel Conducting Plates | 7 |
| Figure 3. Internal Structure of a Seemingly One-Dimensional Object | 9 |
| Figure 4. Manipulated Extra Dimension | 15 |

Figure 5. Artist’s Conception of a Futuristic Warp Drive Spacecraft 16
Figure 6. A Toroidal Higher Dimension 17
Figure 7. A Combination of Phenomenologically Viable Fields 19
Figure 8. False Vacuum Minima 19
Figure 9. Thick and Thin Shell Warp Bubble 21

Tables

Table 1. Transit Times to Various Exotic Destinations at 100 Times the Speed of
Lightvi
Table 2. Negative Energy Required for Warp Bubble (Larger Negative Energy) 3
Table 3. Negative Energy Required for Warp Bubble 22

Warp Drive, Dark Energy, and the Manipulation of Extra Dimensions

Introduction

If one is to realistically entertain the notion of interstellar exploration in timeframes of a human lifespan, a dramatic shift in the traditional approach to spacecraft propulsion is necessary. It has been known and well tested since the time of Einstein that all matter is restricted to motion at sublight velocities ($\ll 3 \times 10^8$ m/s, the speed of light, or c), and that as matter approaches the speed of light, its mass asymptotically approaches infinity. This mass increase ensures that an infinite amount of energy would be necessary to travel at the speed of light, and, thus, this speed is impossible to reach and represents an absolute speed limit to all matter traveling through spacetime.

Even if an engine were designed that could propel a spacecraft to an appreciable fraction of light speed, travel to even the closest stars would take many decades in the frame of reference of an observer on Earth. Although these lengthy transit times would not make interstellar exploration impossible, they would certainly dampen the enthusiasm of governments or private individuals funding these missions. After all, a mission whose success is perhaps a century away would be difficult to justify. In recent years, however, physicists have discovered two loopholes to Einstein's ultimate speed limit: the Einstein-Rosen bridge (commonly referred to as a "wormhole") and the warp drive. Fundamentally, both ideas involve manipulation of spacetime itself in some exotic way that allows for faster-than-light (FTL) travel.

Essentially, the wormhole involves connecting two potentially distant regions of space by a topological shortcut. Theoretically, one would enter the wormhole and instantaneously be transported to the exit located in a distant region of space. Although no observational evidence of wormholes exists, theoretically they can exist as a valid solution to general relativity.

The warp drive—the main focus this paper—involves local manipulation of the fabric of space in the immediate vicinity of a spacecraft. The basic idea is to create an asymmetric bubble of space that is contracting in front of the spacecraft while expanding behind it. Using this form of locomotion, the spacecraft remains stationary inside this "warp bubble," and the movement of space itself facilitates the relative motion of the spacecraft. The most attractive feature of the warp drive is that the theory of relativity places no known restrictions on the motion of space itself, thus allowing for a convenient circumvention of the speed of light barrier.

An advanced aerospace platform incorporating warp drive technology would profoundly alter the capacity to explore—and potentially to colonize—the universe. Because a warp drive is not limited by the speed of light, one can only guess the top speeds such a technology might be capable of achieving. For the sake of argument, let's consider the duration of trips taken by a

spacecraft capable of $100c^1$ for an array of exotic destinations of possible interest. As Table 1 shows, trips to the planets within our own solar system would take hours rather than years, and journeys to local star system would be measured in weeks rather than hundreds of thousands of years.

Table 1. Transit Times to Various Exotic Destinations at 100 Times the Speed of Light

| Destination | Transit Time |
|--------------------|---------------------|
| Mars | 193 seconds |
| Jupiter | 36 minutes |
| Neptune | 4 hours |
| Alpha Centauri | 15 days |
| Epsilon Eridani | 38 days |
| The Orion Nebula | 1.3 years |

Until recently, the warp drive was a concept reserved for science fiction. However, a 1994 paper by Miguel Alcubierre placed the idea on a more solid theoretical footing. Alcubierre (Reference 1) demonstrated that a specific Lorentzian manifold could be chosen that exhibited bubble-like features reminiscent of the warp drive from the popular *Star Trek* television series. The bubble allowed for the surrounding spacetime to move at FTL speeds, and the inhabitants of the bubble would feel no acceleration effects because spacetime itself would be in motion instead of the spacecraft and its inhabitants.

A number of papers have emerged in recent years that build on this original idea. However, these papers do not typically address how one might actually create the necessary spacetime bubble. Our own research directly addresses this question from a new and unique perspective and introduces a novel paradigm shift in the field of warp drive study (Reference 2). More formally, our work approaches the physics of warp drive from the perspective of quantum field theory; this diverges from the more traditional approach to warp drives, which utilizes the physics of general relativity. One of the improvements the model introduces is a dramatic reduction in the overall energy required to create such a phenomenon.

The roadmap to this new idea was the observation that spacetime is currently known to be in a state of accelerated expansion, as demonstrated by the redshifting of galaxies, and the belief that if the mechanism for this expansion could be understood, then it might ultimately be controlled. A popular term used by cosmologists today is "dark energy," an exotic and ubiquitous form of energy that is believed to constitute over 70 percent of the matter-energy content of the universe (Reference 3-6). One salient feature of dark energy is its intrinsic ability to generate negative pressure, causing the fabric of space to expand in the way that is currently observed (Reference 7).

¹ This speed, while somewhat arbitrary, highlights the fact that our galaxy would become far more accessible if or when one discovers how to surpass the speed of light barrier.

Although we know what dark energy does, we do not yet fully understand its nature. We do not understand why it exists or how it is created; we simply know it provides an ever-present force on spacetime, causing the universe to expand. Indeed, recent high-precision experimental observations indicate dark energy may be a cosmological vacuum energy (Reference 8-10). These observations are based on the magnitudes of high-redshift supernova and have been a source of high research activity of late owing to the unexpected discovery that the rate of expansion of the universe is increasing (commonly referred to as accelerated expansion).

One tantalizing aspect of dark energy is that if it were fully understood, and if a technology were developed that could generate and harness the exotic effects of dark energy on the fabric of space, then a warp drive would be one step closer to technological reality. While a full understanding of the true nature of dark energy may be many years away, it is entirely feasible that experimental breakthroughs at the Large Hadron Collider or developments in the field of M-theory could lead to a quantum leap in our understanding of this unusual form of energy and perhaps help to direct technological innovations.

Our own research focuses on gaining an understanding of the physical origin of dark energy. By exploring novel ideas at the forefront of theoretical physics, one is able to propose a physically viable model incorporating some of the cutting-edge ideas emerging from string theory and quantum field theory. This leads to a deeper understanding of the possible origin of dark energy and allows consideration of a mechanism that would allow a sufficiently advanced technology to control the dark energy density in any region of space, and thus the expansion of space. This work has clear implications for the advancement of warp drive research.

This paper is structured as follows: Section 2 reviews the more traditional general relativistic warp drives, the energy required to create them, and the physics required to understand them. Section 3 discusses the cosmological constant, a term featured in Einstein's equation that regulates the contraction and expansion of the spacetime. Section 4 introduces the Casimir energy, which, under certain conditions, may be the phenomenon that physically generates the cosmological constant. Section 5 discusses higher dimensions in physics and their importance in the context of Casimir energy calculations. Section 6 introduces the formulas that demonstrate that the Casimir energies in higher dimensions may in fact be the dark energy that is responsible for the accelerated expansion of the universe. Section 7 relates all the previous concepts together and introduces the novel warp drive paradigm. Section 8 performs original calculations of the energy required to create a superluminal warp drive. Finally, the paper speculates about the technological progress that would be necessary to turn this model into a reality.

2. General Relativistic Warp Drives

Alcubierre (Reference 1) derived a spacetime metric motivated by cosmological inflation that would allow arbitrarily short travel times between two distant points in space. The "warp drive" metric uses coordinates (t, x, y, z) and curve (or worldline) $x = x_{sh}(t)$, $y = 0$, $z = 0$, lying in the t - x plane passing through the origin. Note that x_{sh} is the x -axis coordinate position of the moving spaceship (or warp bubble) frame. The metric¹ specifying this particular spacetime geometry is (Reference 1):

$$ds^2 = -c^2 dt^2 + [dx - v_{sh}(t)f(r_{sh}(t))dt]^2 + dy^2 + dz^2, \quad (2.1)$$

where c is the speed of light, $v_{sh}(t)$ is the speed associated with the curve (or warp bubble speed), and $r_{sh}(t)$ is the Euclidean distance from the curve. The warp bubble shape function $f(r_{sh})$ is any smooth positive function that satisfies $f(0) = 1$ and decreases away from the origin to vanish when $r_{sh} > R$ for some distance R . The geometry of each spatial slice is flat, and spacetime is flat where $f(r_{sh})$ vanishes but is curved where it does not vanish.

The driving mechanism of Equation (2.1) is the York extrinsic time, ϑ . This quantity is defined as (Reference 1):

$$\vartheta = \frac{v_{sh}}{c} \frac{x_{sh}}{r_{sh}} \frac{df}{dr_{sh}}. \quad (2.2)$$

The ϑ behavior of the warp drive bubble provides for the simultaneous expansion of space behind the spacecraft and a corresponding contraction of space in front of the spacecraft. Figure 1 illustrates the ϑ behavior of the warp drive bubble geometry. Thus the spacecraft is enveloped within a warp bubble and can be made to exhibit an arbitrarily large faster-than-light (FTL) speed ($v_{sh} \gg c$) as viewed by external coordinate observers. Even though the worldlines inside the warp bubble region are spacelike for all external observers, the moving spaceship (warp bubble) frame itself never travels outside of its local comoving light cone and thus does not violate special relativity.

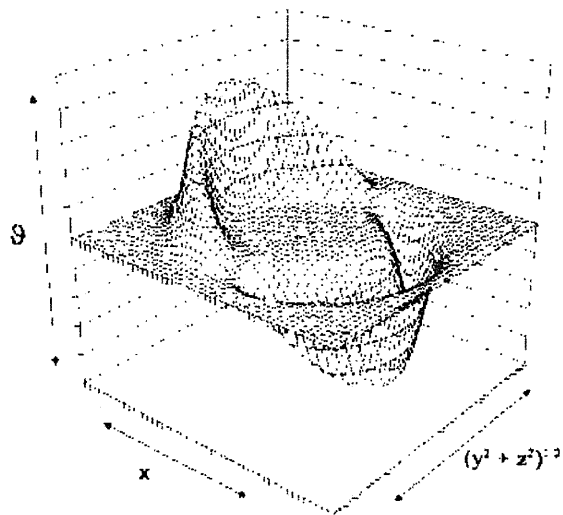

Figure 1. York Extrinsic Time (ϑ) Plot

¹ A spacetime metric (ds^2), or line element, is a Lorentz-invariant distance function between any two points in spacetime that is defined by $ds^2 = g_{\mu\nu} dx^\mu dx^\nu$, where $g_{\mu\nu}$ is the metric tensor which is a 4×4 matrix that encodes the geometry of spacetime and dx^μ is the infinitesimal coordinate separation between two points. The Greek indices ($\mu, \nu = 0 \dots 3$) denote spacetime coordinates, $x^0 \dots x^3$, such that $x^1 \dots x^3 =$ space coordinates and $x^0 =$ time coordinate.

2.1 WARP DRIVE REQUIREMENTS

Implementation of FTL interstellar travel via warp drives requires engineering of spacetime into very specialized local geometries as shown by Equation (2.1). The analysis of these via the general relativistic field equation plus the resultant source matter equations of state demonstrates that such geometries require the use of "exotic" matter in order to produce the requisite FTL spacetime modification. Exotic matter is generally defined by general relativity (GR) physics to be matter that possesses (renormalized) negative energy density and/or negative stress-tension (= positive outward pressure, aka gravitational repulsion). The term is widely misunderstood and misapplied by the non-GR community. Also, it has been claimed that FTL spacetimes are not plausible because exotic matter violates the general relativistic energy conditions.² However, this has been shown to be a spurious issue (Reference 11).

The energy density for the Alcubierre (Reference 1) warp drive that is derived from the general relativistic field equation is complex, so we instead use a more simple formula to express the net energy required, E_{warp} , to build a warp bubble around a spaceship (Reference 12):

$$E_{\text{warp}} = -\frac{v_{\text{warp}}^2 c^4 R^2 \sigma}{G} \quad (2.3)$$

$$= -(1.21 \times 10^{44}) v_{\text{warp}}^2 R^2 \sigma,$$

where G is Newton's universal gravitation constant ($6.673 \times 10^{-11} \text{ N}\cdot\text{m}^2/\text{kg}^2$), v_{warp} is the dimensionless speed of the warp bubble, R (> 0) is the radius of the warp bubble, and σ (> 0) is proportional to the inverse of the warp bubble wall thickness Δ (i.e., $\sigma \sim 1/\Delta$). Equation (2.3) characterizes the amount of negative energy that one needs to localize in the walls of the warp bubble. Table 2 presents a tabulation of the required negative energy as a function of the "warp factor," v_{warp} . One can compare the values of E_{warp} in the table with the (positive) rest-energy contained in the Sun ($1.79 \times 10^{47} \text{ J}$). The consequence of Equation (2.3) and Table 2 is that if one wants to travel at hyperlight speeds, then the warp bubble energy requirement will be an enormous negative number. And this remains true even if one engineers an arbitrarily low sublight speed warp bubble. Engineering a warp drive bubble is quite daunting given these results.

² The condition for ordinary, classical (non-exotic) forms of matter that we are familiar with in nature is that $\rho_E > p$ and/or $\rho_L \geq 0$, where ρ_L is the energy density and p is the pressure/stress-tension of some source of matter. These conditions represent two examples of what are variously called the "standard" energy conditions: Weak Energy Condition (WEC: $\rho_E \geq 0$, $\rho_E + p \geq 0$), Null Energy Condition (NEC: $\rho_E + p \geq 0$), Dominant Energy Condition (DEC), and Strong Energy Condition (SEC). These energy conditions forbid negative energy density between material objects to occur in nature, but they are mere hypotheses. The energy conditions were developed to establish a series of mathematical hypotheses governing the behavior of collapsed-matter singularities in the study of cosmology and black holes.

**Table 2. Negative Energy Required for Warp Bubble
(Larger Negative Energy)**

| Warp Factor, v_{warp} | E_{warp} (J) |
|--------------------------------|------------------------|
| 10^{-5} (= 3 km/s) | -3.03×10^{40} |
| 10^{-4} (= 30 km/s) | -3.03×10^{42} |
| 0.01 (= 3,000 km/s) | -3.03×10^{46} |
| 0.5 (= 150,000 km/s) | -7.59×10^{49} |
| 1 (= light speed) | -3.03×10^{50} |
| 2 (= 600,000 km/s) | -1.21×10^{51} |
| 10 (= 3.0×10^6 km/s) | -3.03×10^{52} |
| 100 (= 3.0×10^7 km/s) | -3.03×10^{54} |

Assume: $R = 50$ m, $\sigma = 10^3$ m⁻¹

Lobo and Visser (Reference 12) constructed an improved model of the warp drive spacetime by applying linearized gravity to the weak-field warp drive case and testing the energy conditions to first and second orders of v_{warp} . The fundamental basis of their model is that it specifically includes a finite mass spaceship that interacts with the warp bubble. Their results verified that all warp drive spacetimes violate the energy conditions and will continue to do so for arbitrarily low warp bubble speed. They also found that the energy condition violations in this class of spacetimes is generic to the form of the geometry under consideration and is not a side effect of the superluminal properties. Based on these facts plus Equation (2.3) and Table 2, it appears that for all conceivable laboratory experiments in which negative energy can be created in minute amounts, the warp bubble speed will be absurdly low.

Coupling of the finite spaceship mass with the warp bubble leads to the (quite reasonable) condition that the net total energy stored in the warp bubble be less than the total rest-energy of the spaceship itself, which places a strong constraint upon the (dimensionless) speed of the warp bubble (Reference 3):

$$v_{\text{warp}} \leq \left[\frac{G}{c^2} \left(\frac{M_{\text{ship}} R_{\text{ship}} \Delta}{R_{\text{ship}} R^2} \right) \right]^{\frac{1}{2}} \tag{2.4}$$

$$\leq \left[(7.41 \times 10^{-28}) \left(\frac{M_{\text{ship}} \Delta}{R^2} \right) \right]^{\frac{1}{2}},$$

where M_{ship} and R_{ship} are the mass and size of the spaceship, respectively, and R is the radius of the warp bubble. Equation (2.4) indicates that for any reasonable values of the engineering parameters inside the brackets, v_{warp} will be absurdly low. This result is due to the intrinsic nonlinearity of the general relativistic field equation. To illustrate this point, the example starship parameters from Table 2 ($R = 50$ m, $\Lambda \sim 1/\sigma = 10^{-3}$ m) are inserted into Equation (2.4) and assume $M_{\text{ship}} = 10^6$ kg to find that $v_{\text{warp}} \leq 1.72 \times 10^{14}$ (or 5.16×10^6 m/s). Garden snails can crawl faster than this. And if R and M_{ship}

are kept constant, then $\Delta = 3.37 \times 10^{24}$ m (or 3.57×10^8 light-years) in order for $v_{\text{warp}} \leq 1$, which is an unrealistic requirement on the warp bubble design.

Because this energy requirement is so phenomenally high one finds it of paramount importance to explore new ideas in the field of warp drive technology. What now follows is a pedagogically rich review of the novel warp drive concept that we have been developing since 2005.

3. The Cosmological Constant

Einstein is famous for a multitude of achievements in the field of physics. Arguably his most notable contribution is the General Theory of Relativity, a geometric description of gravitation whose fundamental idea relates the matter and the energy content of the universe to the geometry of spacetime. Simply put, the presence of matter and energy causes spacetime to curve, and this curvature controls how matter and energy move through spacetime. General relativity has been the prevailing theory of gravitation since 1915 and thus far has unambiguously passed observational and experimental tests. It remains an active area of research and technology is still being developed to test certain features of the theory. Gravitational waves, for example, are one prediction from GR; however, technology is only now reaching the stage of maturity to allow for the detection of these waves.

3.1 EINSTEIN'S EQUATION AND THE INTRODUCTION OF Λ

Upon completion of GR, Einstein applied his theory to the entire universe. He firmly believed in Mach's principle, and the only way to satisfy this was to assume that space is globally closed and that the metric tensor should be determined uniquely from the energy-momentum tensor (Reference 13). He also assumed that the universe was static, which was a reasonable assumption at the time because observational astronomy had not advanced to a level that contradicted this paradigm. In 1917, when a static solution to his equations could not be found, he introduced the cosmological constant Λ (Reference 14):³

$$R_{\mu\nu} - \frac{1}{2} R g_{\mu\nu} = \frac{8\pi G}{c^4} T_{\mu\nu} + \Lambda g_{\mu\nu}. \quad (3.1)$$

In this equation $R_{\mu\nu}$ is the Ricci curvature tensor, R is the Ricci curvature scalar, $T_{\mu\nu}$ is the stress-energy-momentum tensor,⁴ and $g_{\mu\nu}$ is the spacetime metric. The left-hand side of Equation (3.1) encodes the curvature in the geometry of spacetime, and the right-hand side encodes the source of matter-energy that curves spacetime.

The addition of Λ can be understood as a term in the equation which allows one to adjust theory to match observation. In Einstein's case, he chose to add Λ to ensure that the universe was static and unchanging. In later years, he often referred to this amendment to his equations as his "biggest blunder." Several years after GR had been formulated, the astronomer Edwin Hubble discovered the phenomenon of galactic redshifting, which strongly indicated that the universe was indeed expanding. This

³ Pronounced "lambda."

⁴ $T_{\mu\nu}$ encodes the density and flux of a matter source's energy and momentum.

theoretical prediction from GR was ignored by Einstein because of his belief in a static universe.

Even though Einstein retracted the addition of Λ into his equations, it is now known that it does indeed play a role and is typically included in GR equations. Data from precise astronomical observations strongly suggest that an extremely small, yet non-zero Λ is a necessary feature of GR and is responsible for the expansion of the universe that is observed.

From a physical perspective, Λ represents an inherent energy density associated with empty space. One way to envision this is to take a perfectly insulating box into deep space, and then to remove all matter and all energy from this box so that it encloses a perfect void. Even in this emptiness, a residual energy field would remain. According to GR, the effect of this energy would be to cause the region of space to expand, albeit at an extremely small rate. To summarize, Λ is a ubiquitous, ever present feature of space, and its presence causes space to expand.

In the late 1990s it emerged that not only is the universe expanding, but the rate of expansion is, in fact, increasing. Since then, it has become more popular to refer to Λ as dark energy, and the remainder of this paper will follow this convention.

Although the role of dark energy is extremely well understood mathematically, and in the context of its effects on spacetime, its physical nature is still a mystery. One knows that it is homogeneous, not particularly dense, and that it does not interact with any of the fundamental forces of nature. One also knows that it exerts negative pressure on spacetime, which explains the observed accelerated expansion (Reference 15, 16). As there is yet to be a reasonable explanation for the fundamental origin of dark energy, the problem is considered serious and has been tackled by a large number of eminent and respected physicists, including previous Nobel prize winners (Reference 17).

Because dark energy is intimately related to the expansion of space, and because this expansion is exactly the feature that would allow for a warp drive to function, an understanding of this mysterious energy is of paramount importance in the development of this novel propulsion technology.

4. Casimir Energy and the Quantum Vacuum

A central theme in this paper is the notion of the quantum vacuum. To a particle physicist, the term "vacuum" means the ground state of a quantum field in some quantum theory for matter. In general, this ground state must obey Lorentz invariance, at least with regards to three spatial dimensions, meaning that the vacuum must look identical to all observers.

At all energies probed by experiments to date, the universe is accurately described as a set of quantum fields. To a non-physicist a quantum field may, at first, be a strange concept to grasp. This is because one generally likes to visualize the things one thinks about; for example, an electron and even a photon provides something one can, on some level, picture in one's minds. Simply put, a quantum field is an intangible mathematical object whose properties are ideal in explaining nature. Theories have reached such an advanced level that the familiar physical images that one appreciates

must be abandoned for more erudite mathematical constructions which are better suited at describing the building blocks of nature (Reference 18-20).

If one takes the Fourier transform of a free quantum field,⁵ each mode of a fixed wavelength behaves like a simple harmonic oscillator. A quantum mechanical property of a simple harmonic oscillator is that the ground state exhibits zero-point fluctuations as a consequence of the Heisenberg Uncertainty Principle. One way to understand these zero-point fluctuations is to imagine releasing a pendulum and watching as dissipative forces slowly try to bring the pendulum to a stop. The uncertainty principle would ensure that the pendulum was never able to come to a complete rest, but instead would exhibit microscopic oscillations around the equilibrium position indefinitely. Of course, for a real macroscopic pendulum, these fluctuations would be miniscule and all but impossible to detect; however, the analogy with a quantum harmonic oscillator holds well. The expectation value of the energy associated with the ground state energy of a quantum oscillator is:

$$\langle E \rangle = \frac{c}{2} \sum_{n=1}^{\infty} \eta k_n \quad (4.1)$$

In this formula c and \hbar are the speed of light and Planck's reduced constant (1.055×10^{-34} J-s), respectively, and k is the wave-vector related to the momentum of the quantum field. One of the features of this ground state energy is that the wave vector has an infinite degree of freedom. Clearly this sum is divergent; however, this is a common feature of quantum field theory, and an array of mathematical techniques known as renormalization exists to deal with the infinities that arise.

4.1 THE CASIMIR EFFECT

The quantum fluctuations of the vacuum fields give rise to a number of phenomena; however, one is particularly striking. The Casimir Effect, which will be explored in more detail in this paper, is arguably the most salient manifestation of the quantum vacuum. In 1948, H. Casimir published a profound paper where he explained the van der Waals interaction in terms of the zero-point energy of a quantized field (Reference 19). In its most basic form, the Casimir Effect it is realized through the interaction of a pair of neutral parallel conducting plates (with separation distance d). The presence of the plates modifies the quantum vacuum, and this modification causes the plates to be pulled toward each other with a force:

$$F = -\frac{\eta c \pi^2}{240d^4} \quad (4.2)$$

This is a profound result in the sense that the origin of this force cannot be traced back to one of the four fundamental forces of nature (gravity, electromagnetism, and the two nuclear forces), but is a force that is entirely due to a modification of the quantum vacuum.

⁵ By "free" we mean that the field does not interact with other fields.

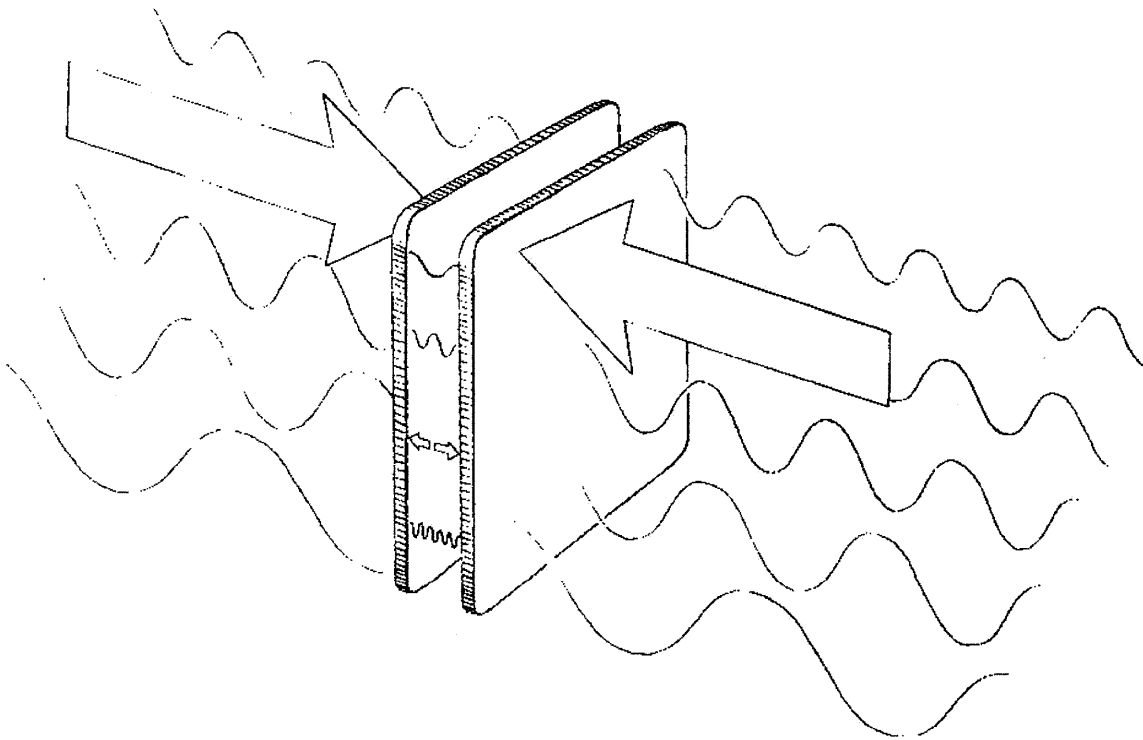

Figure 2. The Interior Region of Parallel Conducting Plates. The region experiences a reduced quantum vacuum energy density owing to the boundary condition the plates impose on the fields. This generates a measurable attractive force that pushes the plates together.

For many years, the paper remained unknown (Reference 22), but from the 1970s onward the Casimir effect received increasing attention, and over the last decade it has become very popular (Reference 23). The Casimir effect is a purely quantum effect. In classical electrodynamics the force between the plates is zero. The ideal scenario occurs at zero temperature when there are no real photons (only virtual photons) between the plates; thus, it is the ground state of the quantum electrodynamic vacuum which causes the attraction. The most important feature of the Casimir effect is that even though it is purely *quantum* in nature, it manifests itself macroscopically. For example, for two parallel plates of area $A = 1 \text{ cm}^2$ separated by a distance of $d = 1 \text{ }\mu\text{m}$ the force of attraction is $F \approx 1.3 \times 10^{-7} \text{ N}$. This force is certainly within the range of laboratory force-measuring techniques.

Typically, the calculations of the expectation value of the vacuum are divergent,⁶ so some form of renormalization must be performed. A full review of the experimental verifications of the Casimir effect are beyond the scope of this paper, but it is certainly worth mentioning that experiments at Washington University using ultra-sensitive Atomic Force Microscopes have experimentally verified the theoretical predictions of the Casimir force to within 1 percent accuracy (Reference 24, 25). Needless to say, many physicists consider this to be a real and well established phenomenon.

⁶ Divergent meaning the equation predicts an infinite result. Divergences are typical in many calculations using quantum field theory, and an array of ingenious tools is used by physicists to extract finite and meaningful results.

In summary, quantum field theory predicts that the vacuum is an interlaced cobweb of quantum fields which are never strictly at rest, and which exhibit zero-point fluctuations. These fluctuations give rise to real and measurable phenomenon, with the Casimir effect being the most poignant. It seems only natural to attempt to relate the ideas from the previous section regarding a ubiquitous dark energy field to this quantum vacuum energy. If a relationship can be established, one would be a step closer to the technological realization of warp drive.

5. Extra Space Dimensions

In connection with the Casimir effect, extra dimensions provide a rich arena for one to generate models that explain the origin of dark energy. Technically speaking, the Casimir effect is a direct consequence of the non-trivial boundary conditions that the presence of the conducting plates imposes upon the quantum vacuum. The quantum modes on the interior region of the plates are restricted, and there is a pressure difference when compared to the quantum vacuum on the exterior region of the plates. It is this pressure difference that causes the plates to attract.⁷

A very similar phenomenon to the Casimir effect can occur when the quantum vacuum energy in *extra space dimensions* are considered. The exploration of this idea has important ramifications in the context of explaining dark energy. Before one can address these ideas it is necessary to review the role of higher space dimensions in physics.

It was Riemann, with his development of differential geometry in the 19th century, who provided the necessary tools to study higher dimensional descriptions of the world (Reference 26). Riemann held the belief that 3-dimensional space was not enough to provide an adequate description of nature. Improvements in physics led to Maxwell's unified theory of electricity and magnetism, and then GR, which unified space and time with Special Relativity (SR). Inspired by these unifications, physicists of the early 20th century wanted to unify gravity and electromagnetism. The first attempt was by Nordstrom in 1914, who used a scalar potential for the gravitational field. Later Weyl and Kaluza, using Einstein's tensor potential, followed two separate paths. Weyl's attempt involved an alteration of the geometry of spacetime in four dimensions. His early attempts had physical consequences which did not match experimental data. However, Weyl's work was extended by Einstein and Schrodinger independently in the Einstein-Schrodinger non-symmetric field theory, which is widely regarded as the most advanced unified field theory based on classical physics.

5.1 KALUZA-KLEIN THEORY

In 1919 Kaluza (Reference 27) offered a unique approach to unifying gravity and electromagnetism which involved adding an additional spatial dimension to GR, and populating this extra dimension with two mathematical objects called a vector potential A_μ and a scalar potential ϕ . The line element in this theory is given by:

⁷ This analogy is not strictly true as different geometries can, in fact, create repulsive Casimir forces and so the pressure analogy breaks down. It is, however, a useful visualization tool.

$$ds^2 = \phi^{1/3} (g_{\mu\nu} + A_\mu A_\nu \phi) dx^\mu dx^\nu + 2\phi^{2/3} A_\mu dx^\mu dy + \phi^{2/3} dy^2 \quad (5.1)$$

where the Greek indices run from 0 to 3 (0 represents the time coordinate and 1...3 the space coordinates), and where the higher dimension is expressed using y . The powers of ϕ are selected for later convenience. Upon solving Einstein's equation in this higher dimensional space using this metric, Kaluza was able to accurately reproduce both GR *and* electromagnetic theory. However, the theory made an additional prediction which was not consistent with observation and was somewhat of an embarrassment for Kaluza.

The main failure of Kaluza's idea, and an issue that caused Einstein to delay his endorsement of the paper by two years, was the very obvious fact that we clearly exist in *three* spatial dimensions and not four. This issue was tackled in 1926 by Oskar Klein (Reference 28), who suggested that the 5th dimension *compactifies*, so as to have the geometry of a circle of extremely small radius. One way to envisage this additional dimension is to imagine a garden hose. It is only when one magnifies the image the toroidal structure is visible. From a long distance it looks like a 1-dimensional line, but a closer inspection reveals that every point on the line is, in fact, a circle (see Figure 3 for an illustration).

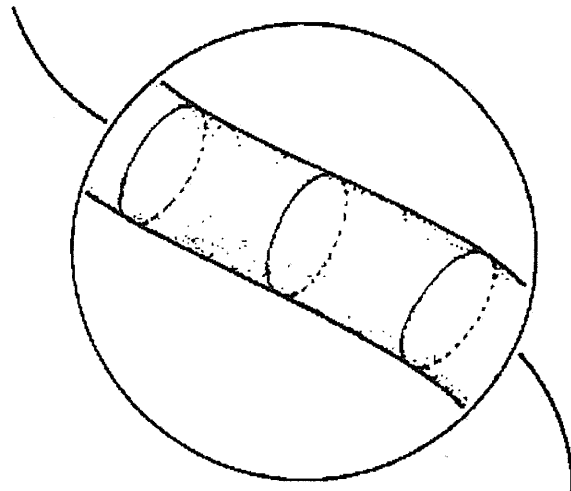

Figure 3. Internal Structure of a Seemingly One-Dimensional Object

While Kaluza-Klein (KK) theory is considered elegant in its simplicity, it is not without problems. One obvious criticism is that the theory is non-predictive, in that it does not *extend* Einstein's or Maxwell's theories, but merely *synthesizes* the formalism within a new mathematical framework. A more serious criticism regards the introduction of the 5th dimension, which was, and still is, seen as an artificial construct since our universe is apparently 4-dimensional.⁸

KK theory remained largely ignored and was considered somewhat obscure for the first half of the twentieth century, as were the speculations regarding additional spatial dimensions. However, the birth of string theory generated a renewed interest in the idea, largely due to string theory's promise of being a quantum theory of gravity.⁹

Unification is one of the main themes in the history of science and is a guiding principle in theoretical physics. Countless examples exist where diverse and seemingly unrelated phenomena have been understood in terms of a small number of underlying principles. In the 1940s, it was demonstrated that quantum mechanics and electromagnetism could be accurately described by quantum field theory, and by the 1970s the weak and

⁸ Including time, of course.

⁹ Quantum gravity is considered somewhat of a "holy grail" within the theoretical physics community.

strong nuclear forces could also be described using QFT. The full theory, called the Standard Model of particle physics, is arguably the most successful physical theory to date.

Despite the successes of the Standard Model, incorporating gravitational interactions using the methods of QFT has proven to be one of the most challenging problems facing theoretical physics today. String theory is currently the best candidate for a quantum theory of gravity (Reference 29). The divergences associated with point particle gravitational interactions are removed in string theory via the extended nature of the string. A review of string theory falls far outside the scope of this paper; however, the theory contains numerous compelling features that deserve mention here. One of the most discussed aspects of string theory is its prediction that additional dimensions of space exist, and are indeed *required* for string theory to work. One of the predictions of string theory is that these additional dimensions are extremely small, on the order of 10^{-35} m. However, there are also popular models which attempt to explain certain aspects of nature that involve large extra dimensions which we will briefly introduce.

5.2 LARGE EXTRA DIMENSIONS

Models with large extra dimensions have enjoyed a revived interest in physics. This began with the Arkani-Hamed, Dimopoulos, and Dvali (ADD) proposal to lower the quantum gravity scale to the 10 to 100 TeV scale¹⁰ (accessible to the next generation of particle accelerators) by embedding the Standard Model fields in a 3+1 dimensional brane existing in a higher dimensional bulk spacetime (Reference 30, 31). Gravity is free to propagate in the bulk, which effectively dilutes its strength. This idea was inspired by M-theory, where it was recognized that the scale of quantum gravity could be lowered from the Planck energy scale to the Grand Unification Theory (GUT) energy scale (Reference 32-35).¹¹ The assumptions underlying the ADD model are:

- n-extra dimensions compactified on a torus with volume $V_n = (2\pi r)^n$.
- Standard Model fields are localized to the brane.
- Gravity can propagate in the bulk.
- There is no cosmological constant in the bulk or on the boundary.
- The brane is stiff.

The bulk action for this model can be given by:

$$S_{bulk} = -\frac{1}{2\int d^{4+n}x\sqrt{-g^{4+n}}}M^{n+2}R. \tag{5.2}$$

where g is the matrix determinant of the metric and the two tilde-quantities are the 4+n dimensional Planck mass and Ricci scalar, respectively. By integrating out the extra dimensions, it is simple to show that:

¹⁰ 1 TeV = 10^{12} eV (1 eV = 1.602×10^{-19} J) is a mass-energy scale used in elementary particle physics.

¹¹ Planck energy $(\hbar c^5/G)^{1/2} \approx 10^{28}$ eV; GUT energy $> 10^{14}$ GeV (1 GeV = 10^9 eV).

$$M_{pl}^2 = (2\pi r)^n M^{n+2} \quad (5.3)$$

M_{pl} is the Planck mass¹² (in our usual 4-dimensional spacetime) and r is the size of the extra space dimensions. This remarkable result indicates that the Planck scale is, in fact, a quantity that is derived from a more fundamental quantum gravity scale and also the volume of the extra dimensions. Physically, this implies that the graviton is diluted across the bulk with a diminished intersection with the familiar 3+1 dimensional brane.

In this type of model the size of the internal space is of order $1/M$ and the effective cosmological constant is on the order $\Lambda_{eff} \sim 8\pi M_{pl}^{-2} \times \frac{10^{-2}}{a^4}$ (Reference 36, 37). Setting the value of the corresponding energy density equal to the known density of dark energy, one finds that the extra-dimensional radius is $r \sim 10^{-3}$ cm. Similar results are found in models with more complicated internal spaces. This is an important result in the context of dimensional manipulation.

Note that extra dimensions that are accessible to *all* the Standard Model fields can also be realized. These models are known as Universal Extra Dimensions (UED). In the case of recent experimental constraints, a compactification scale as low as 1 TeV is allowed.

5.3 RANDALL SUNDRUM BRANE MODELS

The idea that the universe can be modeled as a (mem)brane existing in a higher dimensional bulk spacetime has received a huge amount of attention in recent years (Reference 38-46). It is possible that the brane energy density affects the spacetime curvature, and an approximation can be achieved by first considering a model where branes are located at the two ends of a periodic 5th dimension. To ensure stability of the model two branes are required to balance the bulk energy. To get a stable metric, the effects of the brane on the spacetime must be compensated by a negative cosmological constant in the bulk. Thus, the 5th dimension can be considered a slice of Anti-deSitter (AdS)¹³ space bounded by flat branes, and the price of keeping the branes *flat* is to introduce curvature into the 5th dimension. Such models are termed warped extra dimensions.

The Randall-Sundrum (RS1) model (Reference 47, 48) proposes a novel geometrical solution to the hierarchy problem. The hierarchy problem questions why gravity is so much weaker than the weak force (which is 10^{32} times stronger), and why the Higgs boson is so much lighter than the Planck mass. In the RS1 setup, the Standard Model fields are now confined to one of two 3-branes which lie at the endpoints (i.e., fixed points) of an S^1/Z_2 orbifold,¹⁴ except for the Higgs field. One of the branes physically corresponds to "our" universe and is sometimes referred to as the IR or "visible" brane. The closer a Standard Model field is to the visible brane, the greater its coupling to the

¹² 2.18×10^8 kg.

¹³ Anti-deSitter space is a Lorentzian manifold with a constant negative scalar curvature. In terms of General Relativity, this is a solution to Einstein's field equation with an attractive cosmological constant.

¹⁴ An S^1/Z_2 corresponds to a circular extra dimension with an additional symmetry. This type of projection is popular in a number of higher dimensional models due to its ability to mathematically "project" out certain phenomenologically undesirable fields.

Higgs, and therefore the greater the mass. The second brane is the UV or "hidden" brane. The line element in RS1 is described by the metric:

$$ds^2 = e^{-2kr\phi} \eta_{\mu\nu} dx^\mu dx^\nu - r^2 d\phi^2. \tag{5.4}$$

$\eta_{\mu\nu}$ is the metric tensor for the D-dimensional Minkowski spacetime, the AdS curvature radius is given by $1/k$ and the interbrane separation is given by r . The 5th dimension is compactified on the orbifold of length a , where $0 < \phi < a$. The orbifold fixed points located at $\phi = 0$ and $\phi = a$ correspond to the location of the visible and the hidden brane.

The exponential factor is referred to as the warp factor and is an appealing feature in the RS1 model, as it can both generate a TeV mass scale from the Planck scale in the higher dimensional theory and reduce the effective gravitational strength on the visible brane through the suppression factor $e^{-2kr|\phi|}$ while retaining a bulk width that is only a couple of orders of magnitude above the Planck scale. In addition to the stabilization of the interbrane separation, the quantum effects from the bulk fields (aka the Casimir energy) can also provide a mechanism for the generation of dark energy on the visible brane.

5.4 EXTRA DIMENSION SUMMARY

Although there is still no direct evidence of extra spatial dimensions, there is the possibility that the experiments planned at the Large Hadron Collider could detect particle decay signatures that would indicate the presence of higher dimensions. In fact, all the theoretical groundwork has been performed by theorists, and as soon as the LHC is running smoothly it could, in principle, demonstrate the existence of higher dimensions in a relatively short period of time. Any such discovery would represent a truly radical alteration of our understanding of nature, and many new questions will emerge regarding the potential role extra dimensions could play in advanced technologies (which will be discussed in more detail later in this paper).

6. Dark Energy as a Higher Dimensional Artifact

As discussed earlier, the vacuum of spacetime can be visualized as a sea of quantum fields never fully at rest due to the Heisenberg Uncertainty Principle. The oscillations of the vacuum radiate energy over a range of frequencies in much the same way that an oscillating electron emits electromagnetic energy, and in this way, there exists a ground state energy associated with space itself. The vacuum potential for a periodic scalar field in the ADD model described above is given by (Reference 48-50):

$$V^+ = \frac{\eta c}{2} \sum_{n=-\infty}^{\infty} \int_0^{\infty} \frac{d^4 k}{(2\pi)^4} \log \left[k^2 + \left(\frac{n\pi}{R} \right)^2 + m^2 \right]. \tag{6.1}$$

where k is the momentum modes of the quantum fields, R is the radius of the 5th dimension, and m is the mass of the field. The prime on the summation indicates the $n = 0$ term is excluded. The integral over the continuous momentum modes of the

quantum fields is divergent, as is the infinite summation over the extra-dimensional KK modes; however, as mentioned earlier, dimensional regularization (a form of renormalization) can be used to extract a finite result. This equation differs from Equation (4.1) in that the quantum field that we consider has both mass and a degree of freedom in the higher dimension. Working with a scalar field, the result can later be extended simply for the case of more phenomenologically viable fields (fermions, for example).

Our own research focuses upon exploring a new way to handle the infinities arising from Equation (6.1), and after performing a novel regularization it was discovered that:

$$V^+ = -\frac{\zeta\left(\frac{5}{2}\right)m^2}{32\pi^2 r^2} \sum_{n=1}^{\infty} K_{\frac{5}{2}}(2mrn) \quad (6.2)$$

where ζ is the Riemann zeta function, and $K_{5/2}(2mrn)$ is the modified Bessel function of the second kind. Although the summation is infinite, the function converges rapidly and so a good approximation is obtained by performing the sum up to $n = 10$. Since discovering this formula, the result agrees with derivations of this energy based on different regularization methods and so one is confident in the validity of Equation (6.2).

It is relatively straightforward to calculate the contributions to the vacuum energy density coming from each field in the Standard Model of particle physics. For example, the electron is a fundamental quantum field whose ubiquitous ground state energy contributes to the vacuum energy density. Similarly, the photon is a fundamental quantum field whose ubiquitous ground state energy also contributes to the vacuum energy density. In fact, all Standard Model fields contribute a finite and calculable component to the overall energy density of space.

Equation (5.1) expresses the vacuum energy density for a periodic massive scalar field. Using knowledge of supersymmetry multiplets it is possible to enumerate this energy for all fields occurring in the Standard Model (Reference 49):

$$\begin{aligned} V_{fermion}^-(r) &= -4V^-(r), \\ V_{fermion}^+(r) &= \frac{15}{4}V^+(r), \\ V_{higgs}^+(r) &= 2V^+(r). \end{aligned} \quad (6.3)$$

Also, knowledge of the vacuum energy density for a *massless* field:

$$V_{massless}^- = -\frac{3\zeta(5)}{64\pi^2 r^4}, \quad (6.4)$$

will allow one to fully articulate the energy density of the vacuum in terms of the building blocks of nature. This is expressed algebraically as:

$$\langle E_{vac} \rangle = \sum_{i=1} \tilde{V}_i^+ + V_{higgs} + V_{massless} \quad (6.5)$$

where the index i runs over the spectrum of Standard Model fermions. Using Equation (6.5), and slight variations, we are able to computationally build a model which demonstrates how the vacuum energy density varies as a function of higher dimensional radius. It cannot be overstated that a full understanding of the vacuum structure is of critical importance when attempting to understand the nature of dark energy and to investigate its possible manipulation.

It is important to appreciate that, for example, a physical electron does not actually have to be *present* at a specific point in space for it to contribute to the vacuum energy density. But that the vacuum always has the potential to allow an electron to exist at any point in space. Thus, at all points in space a *virtual electron* exists. This virtual electron is a basic and fundamental feature of the intrinsic makeup of spacetime itself. In this way, empty space has a ground state energy that is due to the *virtual contributions* of all fields that occur in nature: electrons, quarks, photons, and indeed, the entire particle zoo.

Many attempts have been made to relate this vacuum energy to dark energy; however, because these quantum fields are free to oscillate over a wide range of possible frequencies, when one calculates the sum¹⁵ of all the contributions from all possible frequencies of the vacuum, an energy density far in excess of that seen in nature is recovered (Reference 50).

Our own work (Reference 51, 53) has demonstrated that when the contribution due to the extra-dimensional quantum vacuum fields is included, it is possible to "tune" the theoretical energy density of the universe to agree with experimental observations using extensions of Equation (6.5), provided allowance for certain exotic fields to exist within the higher dimension. Although this may at first appear counterintuitive, one novel feature of the quantum vacuum energy is that it can contribute both positive *and* negative energy to the vacuum. The sign of the contribution is fundamentally due to the nature of the underlying virtual quantum field. For example, virtual fermionic fields (e.g., electrons) contribute an overall *positive* energy to the vacuum, whereas virtual bosonic fields contribute an overall *negative* energy. In this way, certain field combinations allow for energy *cancellations*. The additional freedom encountered in higher dimensional theories means that it is a fairly straightforward matter to adjust the overall vacuum energy density to agree with the experimentally measured value for the cosmological constant.

Essentially, this means that one is immediately presented with a natural explanation for the existence of dark energy. Previous attempts to link dark energy to the vacuum energy had yielded grossly high theoretical predictions far in excess of that observed in nature; however, by including the contributions from higher dimensional fields we have shown that the taming of this dark energy density is entirely possible. The significance of this result is that it provides a foundation upon which to explore possibilities relating to warp drive propulsion. More simply, once one knows why space expands, it becomes possible to explore technological possibilities to potentially make space expand.

¹⁵ Technically we integrate over all the possible frequencies.

To summarize, the existence of dark energy may be attributed to the combined effects of vacuum fluctuations in "normal" 3+1 dimensional spacetime plus higher dimensional contributions. If this model proves to be correct, then ideas extending from this paradigm could provide one with intriguing opportunities for technological intervention.

7. Warp Drive and Higher Dimensional Manipulation

Both our own research and previous work in higher dimensional Casimir energy¹⁶ demonstrate that the magnitude of the vacuum energy is intimately related to the *size* of the extra dimension. More precisely, the smaller the extra dimension, the greater the Casimir energy (and vice versa: the bigger an extra dimension, the smaller the Casimir energy). In fact, the energy is related to the radius of the higher dimension raised to the fourth power, which means that very small changes in the radius of the extra dimension generate dramatic changes to the vacuum energy density.

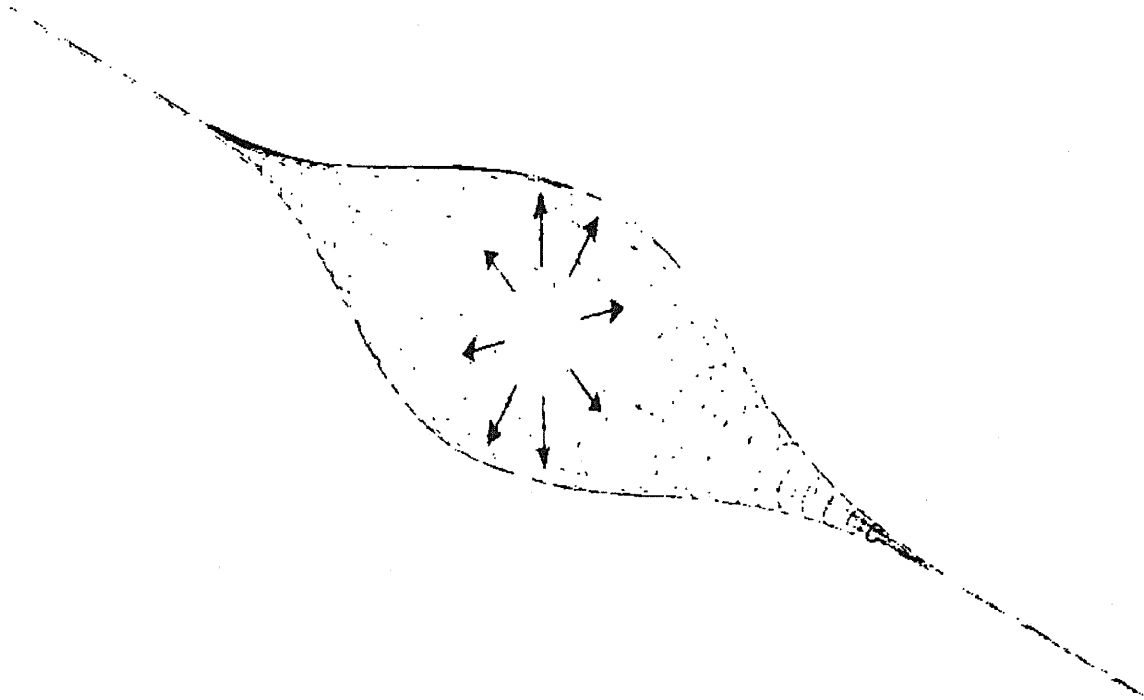

Figure 4. Manipulated Extra Dimension. A sufficiently advanced technology with the capacity to directly interact with and manipulate an extra dimension would be able to locally adjust the dark energy density in a given region of spacetime.

What this means is that if an advanced technology was able to influence the radius of an extra dimension, then it would acquire direct control over dark energy, and hence the expansion and contraction of space itself. As tremendous a feat as this may sound, at this early stage in the research it is one of the only viable mechanisms to generate a warp drive.

¹⁶ Quantum vacuum energy and Casimir energy are often used interchangeably in the literature.

It is worthwhile to expand more on the concept of what we mean by adjusting the radius of the extra dimension.

7.1 ADJUSTING HIGHER DIMENSIONS FOR PROPULSIONS

Figure 4 should assist in the visualization of what a higher dimensional space might look like. In this 1-dimensional example one can see that *all* points have an associated higher dimension. One assumes that generally the radius of the extra dimension is fixed. It is this fixed radius which generates the observed dark energy density and is responsible for the homogeneity in the observed expansion of the universe.

If one were to *locally* adjust the higher dimensional radius then the dark energy density would also change locally. More specifically, if one were to adjust the radius of the extra dimension in the direct *vicinity* of a spacecraft, then the dark energy density would also change only in the vicinity of the spacecraft, as would the expansion of space. It is important at this point to appreciate that *globally*, the universe would continue to expand at the rate we observe today, but that only in the proximity of the spacecraft would space be "stimulated" to expand at some modified rate.

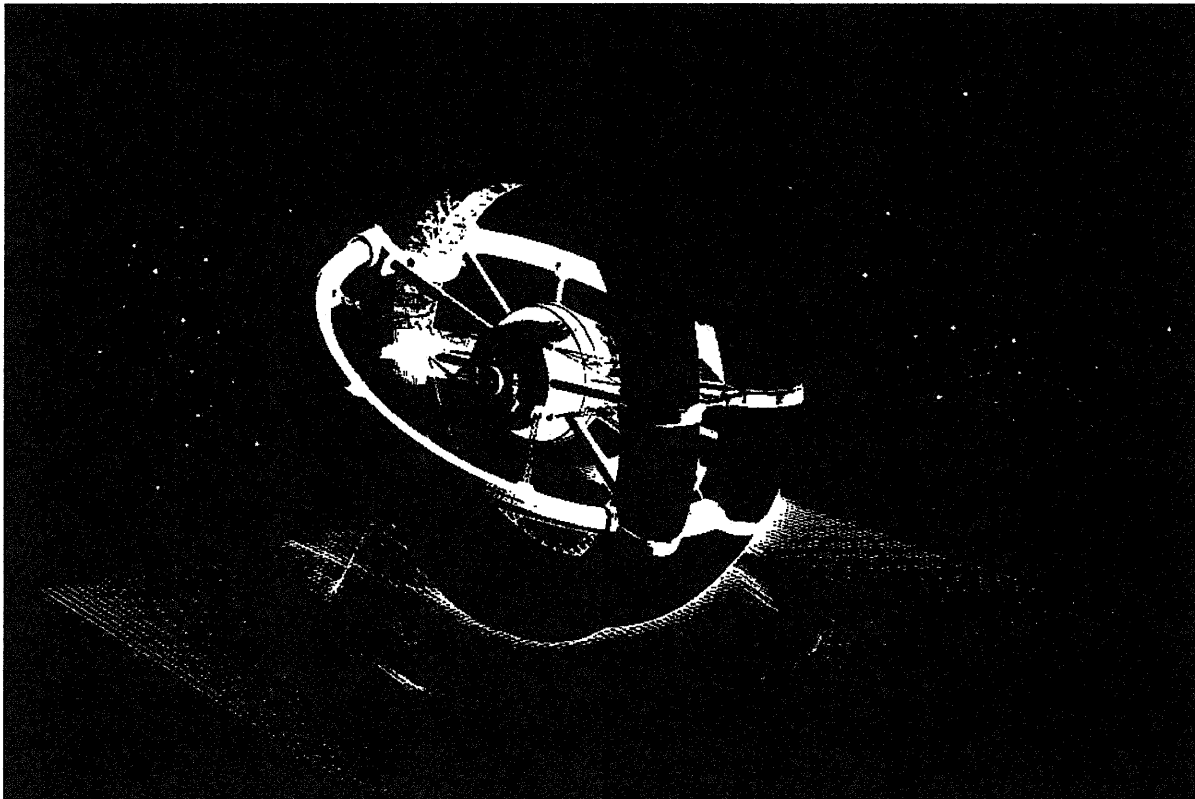

Figure 5. Artist's Conception of a Futuristic Warp Drive Spacecraft. By locally adjusting the size of the extra space dimension, the spacecraft is able to generate the necessary warp bubble required to surpass the light speed barrier.

Of course, obvious questions present themselves. Can one really assume that a higher dimension is circular? Also, if dark energy is responsible for the expansion of space, can we assume that it can somehow be used to *contract* space, and not just expand it?

7.2 THE GEOMETRY OF EXTRA DIMENSIONS

To answer the first question, our most developed higher dimensional theory (M-theory) works in *seven* additional spatial dimensions. The shape is believed to be what mathematicians call a Calabi-Yau manifold – a complex object that is notoriously challenging to work with. Physicists often like to work with simpler models (a single extra dimension, for example) with an uncomplicated shape like the circle. Although this may at first appear to be a gross simplification, often these simplistic higher dimensional models both reflect the flavor of the physics involved, and give accurate predictions that are believed to deviate from nature only at extremely high energies.¹⁷

For this reason, many of the research papers investigating higher dimensions choose to work in the simpler circular higher dimensional space. A smaller fraction of papers explore two additional higher dimensions, which are commonly toroidal (see Figure 6), and an even smaller fraction of papers work in the full M-theoretic Calabi-Yau manifold. At these early stages of investigation, the additional circular dimension represents an adequate approximation. Should the research progress to a more highly developed phase, then it may become necessary to work within the Calabi-Yau manifold.

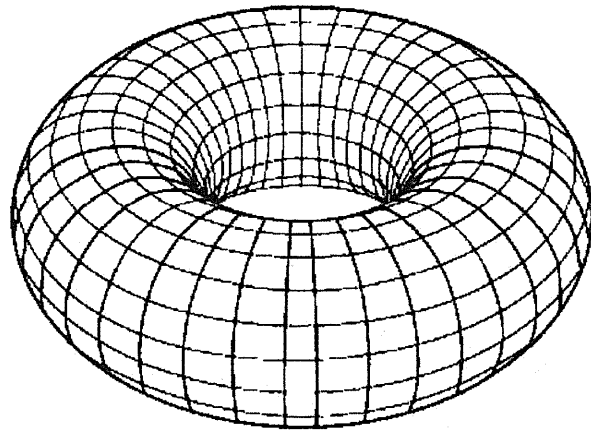

Figure 6. A Toroidal Higher Dimension. This is one of the many possible topologies explored in higher dimensional theories.

With regards to the question of whether space can be made to *contract*, it seems possible if one can make the energy density of a given region of space negative instead of positive. This type of space has been well explored by physicists, and is known as anti-deSitter space. One of the unique features of Casimir energy is that under many conditions it is known to be negative, and thus with a careful manipulation of the higher dimensional fields it is, in principle, possible to generate the required contraction of space.

7.3 HIGHER DIMENSIONS AND STABILIZATION

Our goal in this section is to explore the possibilities of manipulating a higher dimension, which will influence the local dark energy density and thus the expansion and contraction of spacetime in the vicinity of a spacecraft.

Before the issue of how to *manipulate* a higher dimension can be addressed, first one must understand *why* an additional spatial dimension holds some fixed radius. This is a well know problem in higher dimensional physics and is commonly called the problem of "modulus stabilization." Broadly stated, the question is as follows: if there are additional spatial dimensions, why do they not perpetually expand, like our familiar dimensions of space, or alternatively, why do they not perpetually contract? What

¹⁷ For example, in the vicinity of a black hole, or in the first moments of the big bang.

mechanism is it that allows for this higher space to remain compact and stable? Of the handful of theories that attempt to answer this problem, one is particularly appealing due to its naturalness.

A recurring theme throughout this paper is Casimir energy. This energy is compelling due to the fact that it is a natural feature intrinsic to the fabric of space itself. Casimir energy in higher dimensions not only offers the promise of explaining the nature of dark energy, as discussed in previous sections, but can also be utilized as a mechanism to *stabilize* the compact extra dimension.

We have discovered in our research that with a natural combination of fields, and a single exotic component, we are able to generate a stable extra dimension (Reference 51, 53). The way to understand this is as follows: as mentioned earlier, each field in nature contributes a component to the ground state of the vacuum (that is, the state of minimum energy of space) due to the virtual particle contributions. When this energy is calculated for the case of three large and one *compact* spatial dimension, one discovers that this energy is a strong function of the size of the 5th dimension.

In our research, we summed the contributions from all the known fields in nature using extensions of Equation (6.5). We discovered that with the addition of one additional exotic field confined to exist in only the 5th dimension, a stable higher dimensional configuration was found. Our motivations for the addition of extra exotic fields have a strong phenomenological foundation, and these exotic fields been studied successfully in the context of explaining solar neutrino oscillations (Reference 54-56). A full discussion, however, is beyond the scope of this paper.

To understand what is meant by a stable higher dimensional configuration we refer to Figure 7, which is a plot illustrating the vacuum energy density as a function of higher dimensional radius.

The x-axis represents the radius of the higher dimension and the y-axis the energy density of spacetime.¹⁸ We have shown the contributions to the energy density coming from the different fields of the Standard Model, and also the additional exotic field. The overall energy density is illustrated as a thick black line. The most important feature of this graph is the mathematical minimum. A good physical analogy here is to imagine releasing a ball from the far left of the black line: the ball would roll down the line and become stuck in the minimum. The ball becoming stuck in this minimum is an excellent analogy to the dynamics of the higher dimension, which begins at some unstable state, but evolves into a stable configuration.

¹⁸ We work in "normalized" units.

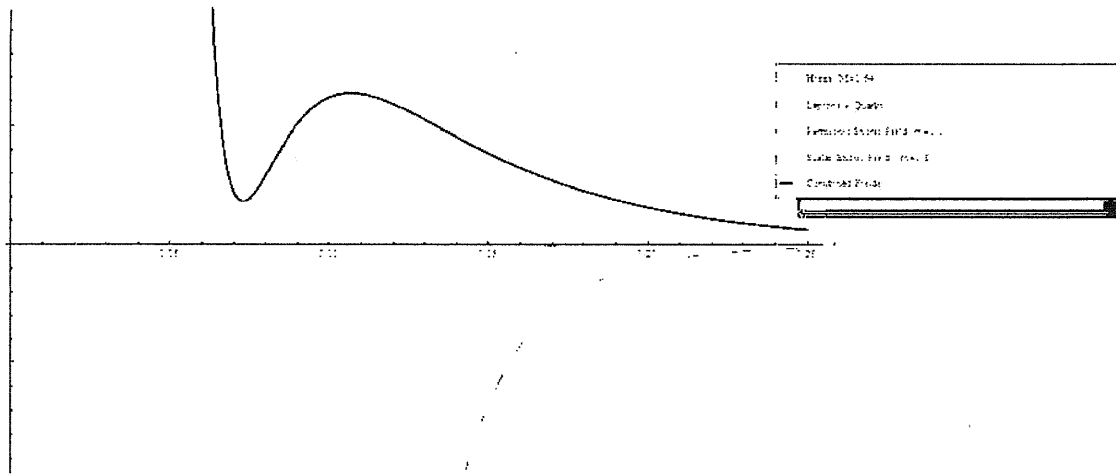

Figure 7. A Combination of Phenomenologically Viable Fields Generates a Stable Minimum of the Vacuum Energy Density at a Fixed Higher Dimensional Radius. This stable minimum, located at a positive energy, indicates a stable deSitter type spacetime and reflects a realistic dark energy model. Note in this plot that the radius of the extra dimensions is shown on the x-axis, and the energy density on the y-axis (normalized units are used).

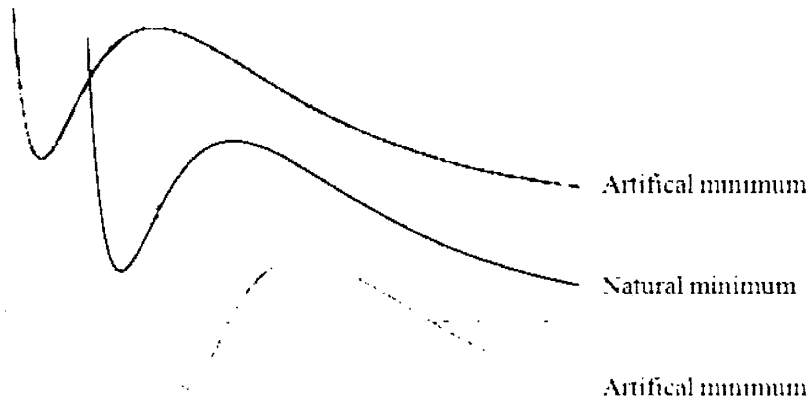

Figure 8. False Vacuum Minima are Created Around a Spacecraft. The different minima create an asymmetric dark energy pressure on 3-space which generates the warp bubble. In this plot the x-axis represents the radius of the extra dimension, and the y-axis represents the energy density (normalized units are used).

The key to creating a warp drive is to create a false vacuum minimum, i.e., to modify the vacuum spectrum and inject some field which creates a deSitter minimum at the rear of the craft and an anti-deSitter minimum at the front of the craft. What this requires is a technology that would allow us to artificially manipulate the field content illustrated in Figure 7, shifting the location of the minimum. In this basic representation, the spacecraft would sit in a stable region of space corresponding to the natural minimum of the extra dimension. At the front and rear of the craft, regions of

false minima would be artificially created via the adjustment of the extra dimension (see Figure 8). These modified regions would correspond to increased and negative dark energy densities, thus creating the warp bubble previously discussed.

7.4 ELEMENTARY WARP DRIVE CALCULATIONS

This section will explore the calculations relevant to propulsion. Specifically, it will determine the energy required to accelerate a spacecraft to the speed of light. By associating the cosmological constant with the higher dimensional Casimir energy, a straightforward relation between Λ and the radius of the extra dimensions can be determined:

$$\rho_{vac} = \Lambda \sim \frac{1}{R^4} \quad (7.1)$$

A simpler way of developing the relationship between the energy density of space and the expansion of space is to express Λ as a function of Hubble's constant, H :

$$H \propto \sqrt{\Lambda}, \quad (7.2)$$

which is a standard result obtained from GR. From these two formula, a relationship between the expansion of space and the radius of the extra dimension can be shown:

$$H \sim \frac{1}{R^2}. \quad (7.3)$$

This formula really expresses the foundation of this novel warp drive concept: that a sufficiently advanced technology with the ability to adjust the radius of the extra dimension *locally* would be able to locally adjust the expansion and contraction of spacetime around a spacecraft. This asymmetric expansion creates the warp bubble illustrated in Figure 1. The spacecraft would always move within its own light cone and thus would not contradict any law of special relativity. The possibility that the higher dimensional radius might vary from place to place has been explored in the context of string theory (Reference 57), and so is a valid academic pursuit. However, it has never before been suggested that this might facilitate a new and exotic form of propulsion.

Equations (7.1) and (7.2) used together express a relationship between the expansion of space and the energy density of space. A sufficient increase in the energy density of space would generate a proportional increase in the expansion of space. Thus calculate the energy density of space that would be necessary to generate a local expansion of space at the speed of light. A local expansion at the speed of light, Hubble's constant must be increased by a factor of:

$$H_c = 10^{26} H, \quad (7.4)$$

where H_c represents the modified Hubble's constant, and the subscript c indicates that it is the Hubble's constant for the case of light speed expansion. H must be increased by a factor of 10^{26} to achieve a local expansion of space equivalent to the speed of light.

Another relevant calculation regards the local energy density required to generate this expansion. A similar calculation to the one just performed indicates that the cosmological constant, an expression which characterizes the energy density of space, must be increased by a factor of 10^{52} . This implies an energy density of:

$$\rho_c = 10^{42} \text{ J/m}^3 \quad (7.5)$$

This is, indeed, an incredible number. However, the total energy requirement would be reduced if we assumed a "thin shell" of modified spacetime. Figure 9 illustrates the case where the warp bubble thickness is reduced. More detailed research is necessary before we could accurately predict the minimum shell thickness that would be necessary to support a stable warp field. However, if a shell could be produced that was merely a single Planck length in thickness, then the energy requirements would be reduced immensely.

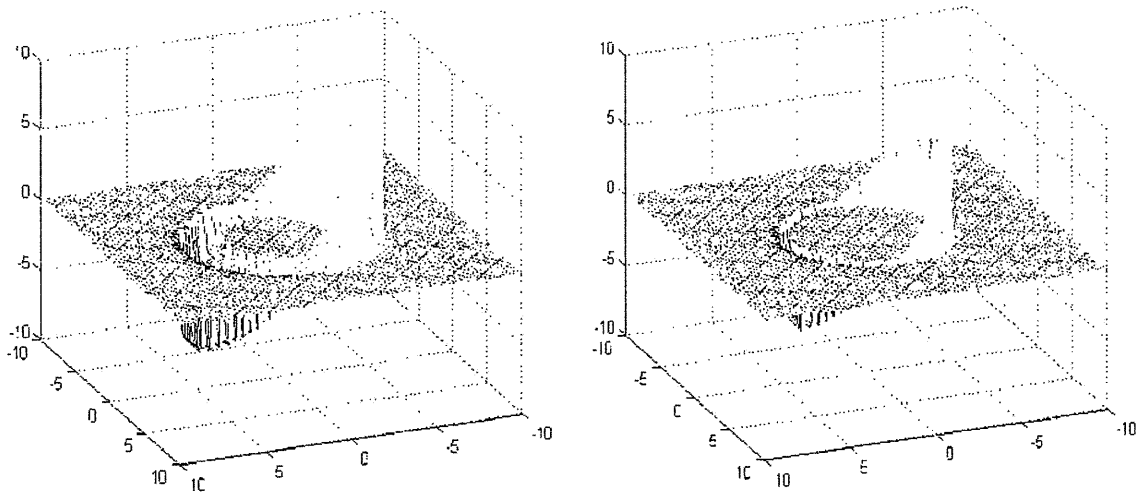

Figure 9. Two Images Illustrating the Contrast Between a Thick (left) and Thin (right) Shell Warp Bubble. A thin shell warp drive model has the capacity to dramatically reduce the energy requirements of a warp drive.

Under this new paradigm of warp drive, where the necessary contracting and expansion of spacetime is generated by a manipulation of the radius of the extra dimension, one can clearly see that the energy requirements are reduced immensely when compared to the calculations of Lobo and Visser (Reference 12). Table 3 illustrates the energy requirements for a range of multiple of the speed of light. All calculations are order-of-magnitude.

Table 3. Negative Energy Required for Warp Bubble

| Warp Factor, v_{warp} | E_{warp} (J) |
|--------------------------------|------------------------|
| 10^{-5} (= 3 km/s) | -1.00×10^{32} |
| 10^{-4} (= 30 km/s) | -1.00×10^{34} |
| 0.01 (= 3,000 km/s) | -1.00×10^{38} |
| 0.5 (= 150,000 km/s) | -2.50×10^{41} |
| 1 (= light speed) | -1.00×10^{42} |
| 2 (= 600,000 km/s) | -4.00×10^{42} |
| 10 (= 3.0×10^6 km/s) | -1.00×10^{44} |
| 100 (= 3.0×10^7 km/s) | -3.03×10^{46} |

Upon comparing Tables 2 and 3, immediately one can see the drastic energy reductions that are apparent when one uses the dimensional warp drive paradigm. The energy requirements are reduced by a factor of 10^8 . This energy is based on a warp bubble that encompasses 100 m^3 of space. As discussed earlier, this is a "worst case" scenario, and the energy requirements could be further reduced, perhaps by many orders of magnitude, by utilizing the thin shell model illustrated in Figure 9.

These are, perhaps, the most important numerical results of this paper, as they set an upper limit on the energy requirements necessary to generate a warp bubble, and also on the energy requirements necessary to surpass the speed of light. Even though this energy requirement is a vast improvement on the calculations of Visser and Lobo, the energies are still far in excess of those available in the foreseeable future.

One interesting prospect to test this theory is to consider the maximum energy density that is achievable by modern technology, and to calculate the expansion of space that this energy would generate. One could then conceivably contemplate a table-top experiment if the numbers allowed. What follows is a description of how this might work.

7.5 FUTURE EXPERIMENTS

At this point we take a diversion into pure speculation as to what technological advancements may be necessary to build a device that might test our dark energy theory. One knows from the Friedmann equations of cosmology that normal matter and energy generate:

$$\frac{\ddot{a}}{a} = -\frac{4\pi G}{3}(\rho + 3p), \quad (7.6)$$

where a is the so-called cosmological scale factor, ρ is the energy density and p is the pressure. If one defines the quantity " $w = \rho/p$ ", one sees immediately that an accelerated expansion of spacetime requires negative pressure. Currently, all known matter and energy generate $w > -1$; however, dark energy has $w = -1$. If it were possible to technologically create dark energy in the lab, then this would assist with our

understanding and experimentation with warp drive technology. To understand how, first discuss an analogy with energy $w > 1$.

In a handful of labs scattered around the country, petawatt lasers are being built and tested. These are lasers of profound capability, able to generate short laser pulses of intensity $\gg 10^{15}$ W/m², with peak focused power densities of $\gg 10^{27}$ W/m³, and energy densities of $\gg 10^{16}$ J/m³. If it were possible to construct an exotic device whose energy output had $w < 1$, then using calculations identical to those to generate Table 3, it would seem straightforward to show that the energy density produced by an analogous dark energy laser would translate into a local expansion of space corresponding to $v_{\text{warp}} = 10^{-13}$ or $\sim 10^{-5}$ m/s for every meter of space that the laser travels. It may be possible to construct an experiment that could measure the modified expansion of space along the length of such a laser to test the predictions of this paper.

7.6 THE DEVELOPMENT OF THE TECHNOLOGY

Although a practical warp drive could be many years away from realization, there are a number of technological developments that may, in fact, be necessary in order to allow prototype experiments to begin. First, a more complete understanding of dark energy is of paramount importance. As mentioned earlier, dark energy contributes approximately 70 percent of the overall energy density of the universe, and is responsible for the expansion of space. As one acquires deeper understanding of this energy, attempts to generate dark energy in the lab would no doubt be a critical component to a working warp drive.

Other crucial developments include determining whether extra dimension are, in fact, real. Once this has been determined with absolute certainty, the role of extra dimensions and their relationship with the universe that we are more familiar with will become a more serious focus of scientific research and attention.

As has been discussed, the stabilization of the extra dimensions and the accelerated expansion of the remaining four dimensions can be realized via the Casimir energy. The acceleration of the 3-dimensional subspace is a naturally occurring phenomenon which occurs when the extra dimensions are stabilized.

An important feature of the higher dimensional model is the dependence of the dark energy density on the size of the extra dimensions. In models with large extra dimensions, the interaction of the graviton KK tower with the Standard Model fields are suppressed by the higher dimensional Planck scale and the corresponding couplings are inverse TeV in strength. This can be seen more clearly when we consider the expansion of the metric tensor in models with large extra dimensions computed within linearized gravity models:

$$g_{MN} = \eta_{MN} + \frac{1}{M_D^{D/2-1}} h_{MN}, \quad 7.7$$

where the capital letter indices indicate summation over the higher dimensions, M is the modified Planck mass, η_{MN} corresponds to flat (Minkowski) spacetime and h_{MN} corresponds to the bulk graviton fluctuations. The graviton interaction term in the action is expressed by:

$$S_{\text{int}} = \frac{1}{M_D^{D/2-1}} \int d^D x h_{MN} T^{MN}, \quad 7.8$$

where T^{MN} is the higher dimensional energy-momentum tensor. The interaction of the graviton with the graviton KK states and with the SM fields are obtained by integrating the action over the extra coordinates. Because all these states are coupled with the universal strength $1/M_{Pl}$ this leads to the compelling possibility of the control of the size of the extra dimensions by processes at energies that will be accessible via the particle accelerators of the near future. Although the coupling is extremely small, the effective coupling is enhanced by the large number of KK states.

Referring to Figure 7, additional energy in the form of matter or radiation with the TeV energy scale can alter the shape of the effective potential. In particular, the extrema determining the size of the extra dimensions are modified with the change of the Casimir energy density and hence, the dark energy density, in the models under consideration.

In the ADD model discussed in Section 5.2, the Standard Model fields are confined to a 4-dimensional brane and a new gravity scale $M_D = G^{2-D} \gg \text{TeV}$ is introduced in the $D = 4 + d$ dimensions, where d is the number of extra dimensions. This is determined quite easily by forming the higher dimensional action and integrating out the extra dimension.

The Atlas experiment at CERN's Large Hadron Collider will have the capability to probe the ADD type extra dimensions up to $M_D \sim 8 \text{ TeV}$. In the Randall Sundrum scenario, the hierarchy is explained by the warp factor in the AdS5 bulk geometry. A lower bound can be placed on the lowest KK mass by electroweak precision tests (masses on the order of 1 TeV are allowed). In the Universal Extra Dimension scenario, Tevatron results constrain the compactification scale to $M_C > 400 \text{ GeV}$. Because the Atlas experiment will be sensitive to $M_C \sim 3 \text{ TeV}$, the estimates in this section indicate that if nature is in fact described by one of these higher dimensional scenarios, then the additional dimensions can be probed.

Even more exciting is the possibility that their size may be controlled at the energies accessible to the Large Hadron Collider. When the Casimir energy to play the role of dark energy is involved, one can see that the possibility for the direct control of the local dark energy density by controlling the size of the additional dimensions is possible.

8. Summary

The idea that a sufficiently advanced technology may interact with, and acquire direct control over, the higher dimensions is a tantalizing possibility, and one that is most certainly worthy of deeper investigation. Control of this higher dimensional space may be a source of technological control over the dark energy density and could ultimately play a role in the development of exotic propulsion technologies; specifically, a warp drive.

Of course, this may not be actualized until many years in the future, but consider the many spectacular physical phenomena that are believed to be true at this early point in

the 21st century. One believes that an energy field called the Higgs boson permeates spacetime and that the interaction of matter with this field is what is responsible for particles acquiring mass. One believes that an exotic ubiquitous energy source, unimaginatively named dark energy, is responsible for the current accelerated expansion of the universe based on observation of supernova in galaxies billions of light years from Earth. One also believes that the universe may not consist of the three spatial dimension of length, breadth, width, and one of time, but that, in fact, there may be as many as seven additional compactified dimensions assuming the topology of a Calabi-Yau manifold, and that the fundamental building blocks of the universe are, in fact, extended string-like entities.

Modern physics is full of many exciting and marvelously imaginative creations. Because one understands these curiosities, one could potentially harness these elements of nature for one's own technological ends. This is by no means a certainty, but if we may make predictions based on the innovative history of scientific pioneers of the past, then it seems entirely possible that the creative minds of the future may indeed find ways to accomplish what, to us, may seem like magic.

¹ Alcubierre, M., "The warp drive: hyper-fast travel within general relativity," *Classical and Quantum Gravity*, vol. 11, 1994, pp. L73-L77.

² Obousy, R and Cleaver, G., "Warp drive: A new approach," *J. Brit. Interplanetary Soc.*, vol. 61, pp. 149, 2008.

³ Wood-Vasey, W., "Observational constraints on the nature of dark energy: First cosmological results from the essence supernova survey," *Astrophys. J.*, vol. 666, pp. 694, 2007.

⁴ Davis, T., "Scrutinizing exotic cosmological models using essence supernova data combined with other cosmological probes," *Astrophys. J.*, vol. 666, pp. 716, 2007.

⁵ Carroll, S., and Press, W., "The cosmological constant," *Ann. Rev. Astron. Astrophys.*, vol. 30, pp. 499-542, 1992.

⁶ Perlmutter, S., "Measurements of the cosmological parameters ω and λ from 42 high-redshift supernovae," *Astrophys. J.*, vol. 517, pp. 565, 1999.

⁷ Straumann, N., "The mystery of the cosmic vacuum energy density and the accelerated expansion of the universe," *European J. Phys.*, vol. 20, pp. 419-427, 1999.

⁸ Schwarzschild, B., "High-redshift supernovae indicate that dark energy has been around for 10 billion years," *Physics Today*, Vol. 60, 2007, pp. 21-25.

⁹ Riess, A. G., et al., "New Hubble Space Telescope Discoveries of Type Ia Supernovae at $z \geq 1$: Narrowing Constraints on the Early Behavior of Dark Energy," *Astrophys. J.*, Vol. 659, 2007, pp. 98- 121.

¹⁰ Astier, P., et al., "The Supernova Legacy Survey: measurement of Ω_M , Ω_Λ , and w from the first year data set," *Astron. Astrophys.*, Vol. 447, 2006, pp. 31-48.

¹¹ Davis, E. W., "Chapter 15: Faster-Than-Light Approaches in General Relativity," *Frontiers of Propulsion Science*, eds. M. G. Millis and E. W. Davis, Progress in Astronautics & Aeronautics Series, Vol. 227, American Inst. of Aeronautics & Astronautics Press, Reston, VA, 2009, pp. 473-509.

¹² Lobo, F. S. N., and Visser, M., "Fundamental limitations on 'warp drive' spacetimes," *Classical and Quantum Gravity*, Vol. 21, 2004, pp. 5871-5892.

¹³ Einstein, A., *The Meaning of Relativity*, Princeton Univ Press, Princeton, USA, 1955.

¹⁴ Einstein, A., *Kosmologische betrachtungen zur allgemeinen relativittstheorie*, Die Naturwissenschaften, vol. 7, pp. 232, 1919.

¹⁵ Sahni, V., and Starobinsky, A., "The case for a positive cosmological lambda-term," *Int. J. Mod. Phys.*, vol. D9, pp. 373, 2000.

¹⁶ Guth, A., "Inflation," *MIT-CTP-3416*, 2004.

¹⁷ Weinberg, S., "The cosmological constant problem," *Rev. Mod. Phys.*, vol. 61, pp. 1-23, 1989.

¹⁸ F. Mandl and G. Shaw, *Quantum Field Theory Revised Edition*, Wiley Press, USA, 1984.

¹⁹ Peskin, M., and Schroeder, D., *An Introduction to Quantum Field Theory*, Perseus Books, Cambridge Massachusetts USA, 1995.

²⁰ Ryder, L., *Quantum Field Theory Second Edition*, Cambridge University Press, Cambridge UK, 1995.

²¹ Casimir, H., "On the attraction between two perfectly conducting plates," *Proc. Kon. Ned. Akad. Wetensch.*, vol. 51, pp. 793, 1948.

²² Bordag, M., "New developments in the Casimir effect." *Phys. Rept.*, vol. 353, pp. 222, 2001.

²³ Milton, K., "The Casimir effect: Recent controversies and progress," *J. Phys. A*, vol. 37, pp. R209, 2004.

²⁴ Lamoreaux, S.K., "Demonstration of the Casimir force in the 0.6 to 6 μm range," *Phys. Rev. Lett.*, vol. 78, pp. 5, 1997.

- ²⁵ Roy, A., Lin, C., and Mohideen, U., "Improved precision measurement of the Casimir Force," *Phys. Rev. D*, vol. 60, pp. 12-16, 1999.
- ²⁶ Kaku, M., *Hyperspace: a scientific odyssey through parallel universes, time warps and the tenth dimension.*, Oxford Univ. Press, Oxford, UK, 1994.
- ²⁷ Kaluza, T., "Zum unitatsproblem in der physik (on the problem of unity in physics)," *Sitzungsber. Preuss. Akad. Wiss. Berlin. (Math. Phys.)*, pp. 966-972, 1921.
- ²⁸ Klein, O., "Quantum theory and the five-dimensional theory of relativity," *Z. Phys.*, vol. 37, pp. 895-906, 1926.
- ²⁹ Polchinski, J., *String Theory, Volume I. An introduction to the bosonic string*, Cambridge Univ. Press, Cambridge, USA, 2001.
- ³⁰ Antoniadis, I., Arkani-Hamed, N., Dvali, G., and Dimopoulos, S., "New dimensions at a millimeter to a fermi and superstrings at a TeV," *Phys. Lett. B*, vol. 436, pp. 257-263, 1998.
- ³¹ Arkani-Hamed, N., Dimopoulos, S., and Dvali, G., "Phenomenology, astrophysics and cosmology of theories with sub-millimeter dimensions and TeV scale quantum gravity," *Phys. Rev. D*, vol. 59, pp. 086004, 1999.
- ³² Antoniadis, I., Arkani-Hamed, N., Dvali, S., Dimopoulos, S., "New dimensions at a millimeter to a fermi and superstrings at a tev," *Phys. Lett. B*, vol. 436, pp. 257-263, 1998.
- ³³ Witten, E., "String theory dynamics in various dimensions," *Nucl. Phys. B*, vol. 443, pp. 85, 1995.
- ³⁴ Horava P., and Witten, E., "Heterotic and type I string dynamics from eleven dimensions," *Nucl. Phys. B*, vol. 460, pp. 506-524, 1996.
- ³⁵ Lykken, J., "Weak scale superstrings," *Phys. Rev. D*, vol. 54, pp. 3693-3697, 1996.
- ³⁶ Saharian, A., "Fermionic Casimir effect in de Sitter spacetime," *Talk given at International Workshop on 60 Years of Casimir Effect*, Brasilia, Brazil, 23-27 Jun 2008
- ³⁷ Saharian, A., "Bulk Casimir densities and vacuum interaction forces in higher dimensional brane models" *Phys. Rev. D*, vol. 73, 064019, 2006.
- ³⁸ Russell, J., "Classical and quantum brane cosmology," *CERN-TH-2000-372*.
- ³⁹ Maartens, R., *Geometry and dynamics of the brane-world*, Reference Frames and Gravitomagnetism, vol 1. World Scientific, city, state, pp. 93-119, 2001.
- ⁴⁰ Langlois, D., "Gravitational and cosmological properties of a brane universe," *Int. J. Mod. Phys. A*, vol. 17, pp. 2701-2706, 2002.
- ⁴¹ Deruelle, N., "Cosmological perturbations of an expanding brane in an anti-de sitter bulk: a short review," *Astrophys. Space Sci.*, vol. 283, pp. 619-626, 2003.
- ⁴² Binetruy, P., Defayet, C., and Langlois, D., "Non-conventional cosmology from a brane-universe," *Nucl. Phys. B*, vol. 565, pp. 269-287, 2000.
- ⁴³ Khoury, J., Ovrut, B., Steinhardt, P., and Turok, N., "The ekpyrotic universe: Colliding branes and the origin of the hot big bang," *Phys. Rev. D*, vol. 64, 123522, 2001.
- ⁴⁴ Tziolas, A., and Wang, A., "Colliding branes and formation of spacetime singularities," *JHEP*, vol. 0904, p. 038, 2009.
- ⁴⁵ Dvali, G., and Tye, H., "Brane ination," *Phys. Lett. B*, vol. 450, pp. 72-82, 1999.
- ⁴⁶ Binetruy, P., De_ayet, C., and Langlois, D., "The radion in brane cosmology," *Nucl. Phys. B*, vol. 615, pp. 219-236, 2001.
- ⁴⁷ Randall, L., and Sundrum, R., "A large mass hierarchy from a small extra dimension," *Phys. Rev. Lett.*, vol. 83, pp. 3370-3373, 1999.
- ⁴⁸ Randall, L., and Sundrum, R., "An alternative to compactification," *Phys. Rev. Lett.*, vol. 83, pp. 4690-4693, 1999.
- ⁴⁹ Ponton, E., and Poppitz, E., "Casimir energy and radius stabilization in five dimensional orbifolds and six-dimensional orbifolds," *JHEP*, vol. 0106, p. 019, 2001.
- ⁵⁰ Ito, M., "Casimir energies due to matter fields in T^2 and T^2/Z_2 compactifications," *Nucl. Phys. B*, vol. 668, pp. 322-334, 2003.
- ⁵¹ Obousy, R., and G. Cleaver, "Casimir energy and brane stability," accepted to *Int. J. Mod. Phys. A*, March 2009. arXiv: 0810.1096.
- ⁵² Zel'dovich, B., "The cosmological constant and the theory of elementary particles," *Soviet Physics Uspekhi*, vol. 11, pp. 381-393, 1968.
- ⁵³ Obousy, R., "Investigation into Compactified Dimensions: Casimir Energies and Phenomenological Aspects," *Ph.D. Dissertation*, Baylor University, Waco, TX, 2008, arXiv: 0901.3640.
- ⁵⁴ Caldwell, D., Mohapatra, R., and Yellin, S., "Large extra dimensions, sterile neutrinos and solar neutrino data," *Phys. Rev. Lett.*, vol. 87, pp. 041601, 2001.
- ⁵⁵ Caldwell, D., Mohapatra, R., and Yellin, S., "A new fit to solar neutrino data in models with large extra dimensions," *Phys. Rev. D*, vol. 64, pp. 073001, 2001.
- ⁵⁶ Dienes, K., Dudas, E., and Gherghetta, T., "Neutrino oscillations without neutrino masses or heavy mass scales: A higher dimensional seesaw mechanism," *Nucl. Phys. B*, vol. 557, pp. 25, 1999.
- ⁵⁷ Giddings, S., "Gravity and strings," *Lecture given at 32nd SLAC Summer Institute on Particle Physics*, vol. SSI, 2004.